

SPECIFICATIONS
FOR
2026 ADA IMPROVEMENTS PROGRAM

URBANDALE, IOWA
PROJECT NO.
2026-008

Prepared By:

ENGINEERING DIVISION
CITY OF URBANDALE
3600 86TH STREET
URBANDALE, IOWA 50322



2026 ADA IMPROVEMENTS PROGRAM
URBANDALE, IA

CIVIL ENGINEER
City of Urbandale
Department of Engineering and Public Works
3600 86th Street
Urbandale, IA 50322

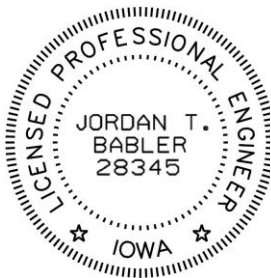

I hereby certify that this engineering document was prepared by me or under my direct personal supervision and that I am a duly Licensed Professional Engineer under the laws of the State of Iowa.

Jordan Babler _____

01/21/2026

Date

License renewal date is December 31, 2026

Pages covered by this seal: Front End Documents

TABLE OF CONTENTS

<u>BIDDING INFORMATION AND CONTRACT DOCUMENTS</u>	<u>PAGES</u>
Notice to Bidders	NOT-1 to NOT-2
Instructions to Bidders	INST-1 to INST-3
Proposal	PROP-1 to PROP-6
Contract	CONT-1 to CONT-6
Performance, Payment and Maintenance Bond	PB-1 to PB-5
Title VI Assurances	TVI-1
Bidder Status Form	BSF-1 to BSF-2
<u>SUPPLEMENTAL SPECIFICATIONS</u>	<u>PAGES</u>
SUDAS Supplemental Specifications	SS-1 to SS-7
<u>PLAN LIST</u>	<u>PAGES</u>
Plan List	PLAN-1

NOTICE TO BIDDERS

2026 ADA IMPROVEMENTS PROGRAM: ADA SIDEWALK RAMP REPLACEMENTS AT VARIOUS LOCATIONS JURISDICTION OF CITY OF URBANDALE PUBLIC IMPROVEMENT PROJECT

Time and Place for Filing Sealed Proposals. Sealed bids for the work comprising the improvement as stated below must be filed before 1:30 p.m. on February 11, 2026, in the Office of the City Clerk, 3600 86th Street, Urbandale, IA 50322.

Time and Place Sealed Proposals Will be Opened and Considered. Sealed proposals will be opened and bids tabulated at 1:30 p.m. on February 11, 2026, in the Office of Engineering and Public Works, 3600 86th Street, Urbandale, IA 50322. Failure to submit a fully completed Bidder Status Form with the bid may result in the bid being deemed nonresponsive and rejected. The City of Urbandale reserves the right to reject any and all bids.

Time for Commencement and Completion of Work. Work on the improvement shall be commenced immediately upon approval of the contract by the Council, and be completed as stated below.

Contract Documents. Copies of the contract documents are available online from the City of Urbandale website, under the Department of Engineering and Public Works, Projects Out to Bid, at www.urbandale.org/185/Projects-Out-to-Bid.

Sales Tax Exemption. Contractors and subcontractors shall not include sales tax for material purchases. At the time of the contract acceptance by the City Council, the prime contractor and all subcontractors will be issued a certificate of exemption.

Title VI of the Civil Rights Act. The City of Urbandale, in accordance with Title VI of the Civil Rights Act of 1964, 78 Stat. 252, 42U.S.C. 2000d to 2000d-4 and Title 49, Code of Federal Regulations, Department of Transportation, Subtitle A, Office of the Secretary, Part 21, Nondiscrimination in Federally-assisted programs of the Department of Transportation issued pursuant to such Act, hereby notifies all bidders that it will affirmatively insure that in any contract entered into pursuant to this advertisement, minority business enterprises will be afforded full opportunity to submit bids in response to this invitation and will not be discriminated against on the grounds of race, color, or national origin in consideration for an award.

Performance Bond and Payment Provisions. The successful bidder will be required to furnish Performance Bond in an amount equal to one hundred percent (100%) of the contract price, said bond to be issued by a responsible surety and shall guarantee the faithful performance of the contract and the terms and conditions therein contained and shall guarantee the prompt payment for all materials and labor and protect and save harmless the City, from claims and damages of any kind caused by the operation of the Contractor.

Payment of the cost of said project will be made from any one or a combination of the following sources at the discretion of the Council:

Cash from such funds as may be legally used for said purpose.

Payments will be made to the Contractor based on monthly estimates in amounts equal to ninety-seven percent (97%) of the contract value of the work completed, and will be based upon an estimate prepared on the first day of each month by the Contractor, subject to verification by City Engineer and the approval of the Clerk, who will certify to the Owner for payment of each approved estimate on or before the 10th day of the month in question. Such monthly payment will in no way be construed as an act of acceptance for any part of the work partially or totally completed. The balance of the three percent (3%) due the Contractor will be paid, subject to the conditions

and in accordance with the provisions of Chapters 26 and 573 of the Code of Iowa, as amended. No partial or final payment will be due until the Contractor has certified to Owner, that the materials, labor and services involved in each estimate have been paid for in accordance with the requirements stated in the specifications.

Preference of Products. By virtue of statutory authority, a preference will be given to products and provisions grown and coal produced within the State of Iowa.

Reciprocal Resident Bidder and Labor Force Preference. In accordance with Iowa law, a resident bidder shall be allowed a preference as against a nonresident bidder from a state or foreign country if that state or foreign country gives or requires any preference to bidders from that state or foreign country, including but not limited to any preference to bidders, the imposition of any type of labor force preference, or any other form of preferential treatment to bidders or laborers from that state or foreign country. The preference allowed shall be equal to the preference given or required by the state or foreign country in which the nonresident bidder is a resident. In the instance of a resident labor force preference, a nonresident bidder shall apply the same resident labor force preference to a public improvement in this state as would be required in the construction of a public improvement by the state or foreign country in which the nonresident bidder is a resident.

General Nature of Public Improvement

The 2026 ADA IMPROVEMENTS PROGRAM shall include:

- Approximately 250 SY of 4" PCC Sidewalk
- Approximately 150 SY of 6" PCC Ramps/Landing Spaces
- Approximately 300 LF of Curb and Gutter
- Approximately 100 SY of PCC Patching
- Related items including removals, restoration, traffic control, erosion control, and survey.

Contractor shall fully complete the project by September 25, 2026.

Bid documents available at no cost.

INSTRUCTIONS TO BIDDERS

2026 ADA IMPROVEMENTS PROGRAM

The work comprising the above referenced project shall be constructed in accordance with the latest Edition of the SUDAS Standard Specifications and as further modified by supplemental specifications and special provisions included in the contract document. The terms used in the contract revision of the documents are defined in said Standard Specifications. Before submitting your bid, please review the requirements of Division One, General Provisions and Covenants, in particular the sections regarding proposal requirements, bonding, contract execution and insurance requirements. Please be certain that all documents have been completed properly, as failure to complete and sign all documents and to comply with the requirements listed below can cause your bid not to be read.

I. SUBMISSION OF THE PROPOSAL AND IDENTITY OF BIDDER

A. The proposal shall be sealed in an envelope, properly identified as the Proposal with the project title and the name and address of the bidder, and deposited with the Jurisdiction at or before the time and at the place provided in the Notice to Bidders. It is the sole responsibility of the bidder to see that its proposal is delivered to the Jurisdiction prior to the time for opening bids. Any proposal received after the scheduled time for the receiving of proposals will be returned to the bidder unopened and will not be considered. If the Jurisdiction provides envelopes for proposals, bidders shall be required to utilize such envelopes in the submission of their bids.

B. The following documents shall be completed, signed and returned in the Proposal envelope. The bid cannot be read if any of these documents are omitted from the Proposal envelope.

1. PROPOSAL – Complete each of the following parts:

- Part B – Acknowledgment of Addenda, if any have been issued;
- Part C – Bid Items, Quantities and Prices
- Part F – Additional Requirements;

The following documents must be completed and attached:

ITEM NO.	DESCRIPTION OF ATTACHMENT
1.	Bidder Status Form
2.	_____
3.	_____
4.	_____

- Part G – Identity of Bidder;

Sign the proposal. The signature on the proposal and all proposal attachments must be an original signature in ink signed by the same individual who is the Company Owner or an authorized Officer of the Company; copies or facsimile of any signature will not be accepted.

Continued – Instructions to Bidders

The following documents must be submitted as printed. No alterations, additions, or deletions are permitted. If the Bidder notes a requirement in the contract documents which the Bidder believes will require a conditioned or unsolicited alternate bid, the Bidder must immediately notify the Jurisdictional Engineer in writing. The Jurisdictional Engineer will issue any necessary interpretation by an addendum.

II. SUBMISSION OF BIDS

- A. Bids shall be submitted on the Proposal form included herewith. The Proposal shall be submitted in a sealed envelope. The envelope shall bear the return address of the Bidder and shall be addressed as follows:

TO: City Clerk
City of Urbandale
3600 86th Street
Urbandale, Iowa 50322

PROPOSAL FOR: 2026 ADA IMPROVEMENTS PROGRAM

- B. The Bid shall be signed by a legally authorized representative of the Bidder.
- C. *Section reserved for future use.*
- D. Contractors and subcontractors shall not include sales tax for material purchases. At the time of the contract acceptance by the City Council, the prime contractor and all subcontractors will be issued a certificate of exemption.

III. QUESTIONS AND ADDENDA

- A. If any person contemplating submitting a Bid for the proposed work, material, or equipment is in doubt as to the true meaning of any part of the Plans, Specifications, or other Contract Documents, the Bidder may request an interpretation thereof. The person submitting the request will be responsible for its prompt delivery.
- B. Questions concerning interpretation or intent of the Contract Documents should be directed to:

City of Urbandale
Department of Engineering and Public Works
3600 86th Street
Urbandale, IA 50322
(515) 278-3950

- C. Any oral interpretation given will be valid only if confirmed by written Addendum. Information obtained from an officer, agent, or employee of the Owner shall not affect the risks or obligations assumed by the Contractor or relieve the Contractor from fulfilling any of the conditions of the Contract.
- D. The Owner reserves the right to revise or amend the Contract Documents, prior to the date set for receipt of Bids. Such revisions and amendments, if any, will be announced by an Addendum or Addenda to the Contract Documents.

Continued – Instructions to Bidders

- E. Copies of such addenda as may be issued will be furnished to all holders of Specifications.
- F. Bidders are required to acknowledge receipt of all Addenda by listing such Addenda in Proposal.

IV. FIELD TESTS

- A. The City of Urbandale will retain an independent testing laboratory to complete the following testing on the project unless modified elsewhere in the plans:
 - 1. Portland Cement Concrete Testing.
 - 2. Earthwork Compaction and Subgrade Testing.
 - 3. Utility Ditch Compaction.
- B. Contractor shall notify Engineer when installation is complete and ready for testing.
- C. The Contractor is responsible for testing required in the Urban Standard Specifications which is not covered in Item V.A above.
- D. If test results do not meet those specified, the Contractor shall make necessary corrections and repeat tests to demonstrate that test requirements are satisfied.
- E. The Contractor shall provide assistance to the City in testing procedures.
- F. Contractor shall certify that sources of PC cement and aggregates for pavement are Iowa DOT approved and provide analysis of materials used.

PROPOSAL

BIDDER: _____

PROPOSAL: PART A – SCOPE

The City of Urbandale, hereinafter called the “Jurisdiction”, has need of a qualified contractor to complete the work comprising the below referenced improvement. The undersigned Bidder hereby proposes to complete the work comprising the below referenced improvement as specified in the contract documents, which are officially on file with the Jurisdiction, in the office of the City Clerk, at the prices hereinafter provided in Part C of the Proposal, for the following described improvements:

The 2026 ADA IMPROVEMENTS PROGRAM shall include:

- Approximately 250 SY of 4” PCC Sidewalk
- Approximately 150 SY of 6” PCC Ramps/Landing Spaces
- Approximately 300 LF of Curb and Gutter
- Approximately 100 SY of PCC Patching
- Related items including removals, restoration, traffic control, erosion control, and survey.

PROPOSAL: PART B – ACKNOWLEDGMENT OF ADDENDA

The Bidder hereby acknowledges that all addenda become a part of the contract documents when issued, and that each such addendum has been received and utilized in the preparation of this bid. The Bidder hereby acknowledges receipt of the following addenda by inserting the number of each addendum in the blanks below:

ADDENDUM NUMBER _____ ADDENDUM NUMBER _____

ADDENDUM NUMBER _____ ADDENDUM NUMBER _____

and certifies that said addenda were utilized in the preparation of this bid.

PROPOSAL: PART C – BID ITEMS, QUANTITIES AND PRICES

UNIT BID PRICE CONTRACTS: The Bidder must provide the Unit Bid Price, the Total Bid Price, any Alternate Prices and the Total Construction Costs on the Proposal Attachment: Part C – Bid Items, Quantities, and Prices. In case of discrepancy, the Unit Bid Price governs. The quantities shown on the Proposal Attachment: Part C – Bid Items, Quantities and Prices are approximate only, but are considered sufficiently adequate for the purpose of comparing bids. The Total Construction Cost plus any alternates selected by the Jurisdiction, shall be used only for comparison of bids.

BASE BID CONTRACTS: The Bidder must provide any Bid Prices, any Alternate Prices, and the Total of the Base Bid plus any Add-Alternates on the Proposal Attachment: Part C – Bid Items, Quantities, and Prices. The Total of the Base bid plus any Alternates selected by the Jurisdiction, shall be used only for comparison of bids.

PROPOSAL: PART D – GENERAL

The Bidder hereby acknowledges that the Jurisdiction, in advertising for public bids for this project reserves the right to:

1. Reject any or all bids. Award of the contract, if any, to be to the lowest responsible, responsive bidder; and
2. Reject any or all alternates in determining the items to be included in the contract. Designation of the lowest responsible, responsive bidder to be based on comparison of the total bid plus any selected alternates; and
3. Make such alterations in the documents or in the proposal quantities as it determines necessary in accordance with the contract documents after execution of the contract. Such alterations shall not be considered a waiver of any conditions of the contract documents, and shall not invalidate any of the provisions thereof; and

The Bidder hereby agrees to:

1. Enter into a contract, if this proposal is selected, within ten (10) days of notice of selection, in the form approved by the Jurisdiction, provide proof of registration with the Iowa Division of Labor in accordance with Chapter 91C of the Iowa Code, and furnish a performance, maintenance, and payment bond; and
2. Commence the work on this project on or before a date to be specified in a written notice to proceed by the Jurisdiction, and to fully complete the project by September 25, 2026; and to pay liquidated damages for noncompliance with said completion provisions at the rate of five hundred dollars (\$500.00) for each day thereafter that the work remains incomplete.

PROPOSAL: PART E – NON-COLLUSION AFFIDAVIT

The Bidder hereby certifies:

1. That this proposal is not affected by, contingent on, or dependent on any other proposal submitted for any improvement with the Jurisdiction; and
2. That no individual employed by the Bidder has employed any person to solicit or procure the work on this project, nor will any employee of the Bidder make any payment or agreement for payment of any compensation in connection with the procurement of this project; and
3. That no part of the bid price received by the Bidder was or will be paid to any person, corporation, firm, association, or other organization for soliciting the bid, other than the payment of their normal compensation to persons regularly employed by the Bidder whose services in connection with the construction of the project were in the regular course of their duties for the Bidder; and
4. That this proposal is genuine and not collusive or sham; that the Bidder has not colluded, conspired, connived or agreed, directly or indirectly, with any bidder or person, to submit a sham bid or to refrain from bidding, and has not in any manner, directly or indirectly, sought, by agreement or collusion, or communication or conference, with any person, to fix the bid price of the Bidder or of any other bidder, and that all statements in this proposal are true; and
5. That the individual(s) executing this proposal have the authority to execute this proposal on behalf of the Bidder.

PROPOSAL: PART F – ADDITIONAL REQUIREMENTS

The Bidder hereby agrees to comply with the additional requirements listed below which are included in this proposal and identified as proposal attachments:

ITEM NO.	DESCRIPTION OF ATTACHMENT
1.	Bidder Status Form
2.	_____
3.	_____
4.	_____

PROPOSAL: PART G – IDENTITY OF BIDDER

The Bidder shall indicate whether the bid is submitted by a/an:

- Individual/Sole Proprietorship
- Partnership
- Corporation
- Limited Liability Company
- Joint-venture: all parties must join-in and execute all documents
- Other

Bidder

Signature

By: _____
Name (PRINT or TYPE)

Title

Street Address

City, State, Zip Code

Telephone Number

Email Address

The Bidder shall enter its Public Registration Number issued by the Iowa Commissioner of Labor Pursuant Section 91C.5 of the Iowa Code:

_____ - _____

Federal Tax ID Number:

NOTE: *The signature on this proposal must be an original signature in ink; copies or facsimile of any signature will not be accepted.*

PROPOSAL ATTACHMENT: PART C – BID ITEMS, QUANTITIES, AND PRICES

This is a UNIT BID PRICE CONTRACT. The bidder must provide the Unit Bid Price, the Total Bid Price, any Alternate Price(s) and the Total Construction Cost; In case of discrepancy, the Unit Bid Price governs. The quantities shown on the Proposal Attachment: Part C – Bid Items, Quantities and Prices are approximately only, but are considered sufficiently adequate for the purpose of comparing bids. The Total Construction Cost plus any alternate selected by the Jurisdiction shall be used only for comparison of bids.

<i>Item</i>	<i>Description</i>	<i>Unit</i>	<i>Quantity</i>	<i>Unit Price</i>	<i>Total Price</i>
1	VALVE BOX EXTENSION	EA	1.0		
2	MANHOLE ADJUSTMENT, MINOR	EA	3.0		
3	CURB AND GUTTER	LF	330.0		
4	REMOVAL OF SIDEWALK	SY	405.3		
5	SIDEWALK , PCC, 4"	SY	236.8		
6	SIDEWALK , PCC, 6"	SY	168.8		
7	DETECTABLE WARNINGS	SF	280.0		
8	FULL-DEPTH PATCH, PCC, 8"	SY	83.7		
9	TEMPORARY TRAFFIC CONTROL	LS	1.0		
Total Project Cost:					

* ITEM DOES NOT HAVE TO BE INCLUDED IN 4-YEAR MAINTENANCE BOND BUT SHALL BE COVERED BY A 1-YEAR MAINTENANCE BOND.

NOTE: IT IS UNDERSTOOD THAT THE ABOVE QUANTITIES ARE ESTIMATED FOR THE PURPOSE OF THIS BID. ALL QUANTITIES ARE SUBJECT TO REVISION BY THE CITY. QUANTITY CHANGES WHICH AMOUNT TO TWENTY (20) PERCENT OR LESS OF THE TOTAL BID SHALL NOT AFFECT THE UNIT BID PRICE.

PROPOSAL ATTACHMENT: PART F – ADDITIONAL REQUIREMENTS

PROPOSAL: PART F – ADDITIONAL REQUIREMENTS

ITEM 1: Bidder Status Form
Bidder Status Form

PROPOSAL: PART F – ADDITIONAL REQUIREMENTS

ITEM 2:

PROPOSAL: PART F – ADDITIONAL REQUIREMENTS

ITEM 3:

PROPOSAL: PART F – ADDITIONAL REQUIREMENTS

ITEM 4:

CONTRACT

THIS CONTRACT, made and entered into this ___ day of ___, ___, by and between the City of Urbandale, upon order of its City Council hereinafter called the "Jurisdiction", and Contractor, hereinafter called the "Contractor".

WITNESSETH:

The Contractor hereby agrees to complete the work comprising the below referenced improvement as specified in the contract documents, which are officially on file with the Jurisdiction, in the office of the City Clerk. This contract includes all contract documents. The term "contract documents" includes the following:

- A. Notice to Bidders and Notice of Public Hearing
- B. Instructions to Bidders
- C. Proposal
- D. Bid Bond (if required)
- E. Contract
- F. Contract Attachments and Appendix
- G. Special Provisions
- H. Performance, Payment, and Maintenance Bond
- I. Supplemental Specifications
- J. Plans and Drawings
- K. Addenda
- L. Change Orders
- M. Notice to Proceed

The work under this contract shall be constructed in accordance with the SUDAS Standard Specifications, latest edition in effect at the time of execution of this Contract, and as further modified by the supplemental specifications and special provisions included in said contract documents, and the Contract Attachment which is attached hereto. The Contractor further agrees to complete the work in strict accordance with said contract documents, and guarantee the work as required by law, for the time required in said contract documents, after its acceptance by the Jurisdiction.

This contract is awarded and executed for completion of the work specified in the contract documents for the bid prices shown on the Contract Attachment: Bid Items, Quantities and Prices which were proposed by the Contractor in its proposal submitted in accordance with the Notice to Bidders for the following described improvements:

The 2026 ADA IMPROVEMENTS PROGRAM shall include:

- Approximately 250 SY of 4" PCC Sidewalk
- Approximately 150 SY of 6" PCC Ramps/Landing Spaces
- Approximately 300 LF of Curb and Gutter
- Approximately 100 SY of PCC Patching
- Related items including removals, restoration, traffic control, erosion control, and survey.

Continued - Contract

The Contractor agrees to perform said work for and in consideration of the Jurisdiction's payment of the bid amount of ____ (\$____) which amount shall constitute the required amount of the performance, maintenance, and payment bond. The Contractor hereby agrees to commence work under this contract on or before a date to be specified in a written notice to proceed by the Jurisdiction and to fully complete the project by September 25, 2026; and to pay liquidated damages for noncompliance with said completion provisions at the rate of five hundred dollars (\$500.00) for each one calendar day thereafter that the work remains incomplete.

If this project has an NPDES permit, by entering into this Contract, the Contractor agrees to be and is made a co-permittee to the Iowa Department of Natural Resources NPDES General Permit No. 2 for "Storm Water Discharge Associated with Industrial Activity for Construction Activities" on the identified site. The Contractor shall carry out the terms and conditions of General Permit No. 2 and the storm water pollution prevention plan, which is a part of these contract documents, and agrees to the following statement:

"I certify under penalty of law that I understand the terms and conditions of the general National Pollutant Discharge Elimination System (NPDES) permit that authorizes the storm water discharges associated with industrial activity from the construction site as part of this certification. Further, by my signature, I understand that I am becoming a co-permittee, along with the owner (s) and other contractors and subcontractors signing such certification, to the Iowa Department of Natural Resources NPDES General Permit No. 2 for "Storm Water Discharge Associated with Industrial Activity for Construction Activities" as the identified site. As a co-permittee, I understand that I, and my company, are legally required under the Clean Water Act and the Code of Iowa, to ensure compliance with the terms and conditions of the storm water pollution prevention plan developed under this NPDES permit and the terms of this NPDES permit."

Continued - Contract

IN WITNESS WHEREOF, the Parties hereto have executed this instrument, in triplicate on the date first shown written.

JURISDICTION

CONTRACTOR

By _____
Mayor

Contractor

(Seal)
ATTEST:

By _____
Signature

City Clerk

Title

Street Address

City, State, Zip Code

Telephone

CONTRACTOR PUBLIC REGISTRATION INFORMATION To Be Provided By:

1. All Contractors: Contractor shall enter its Public Registration Number ____ - ____ issued by the Iowa Commissioner of Labor pursuant to Section 91C.5 of the Iowa Code.
2. Out-of-State Contractors:
 - A. Pursuant to Section 91C.7 of the Iowa Code, an out-of-states contractor, before commencing a contract in excess of five thousand dollars in value in Iowa, shall file a bond with the division of labor services of the department of workforce development. It is the contractor's responsibility to comply with said Section 91C.7 before commencing this work.
 - B. Prior to entering into contract, the designated low bidder, if it is a corporation organized under the laws of a state other than Iowa, shall file with the Engineer a certificate from the Secretary of the State of Iowa showing that it has complied with all the provisions of Chapter 490 of the Iowa Code, or as amended, governing foreign corporations.

CONTRACT ATTACHMENT: ITEM 1: GENERAL

No General Attachment

CONTRACT ATTACHMENT: ITEM 2: BID ITEMS, QUANTITIES

THIS CONTRACT IS AWARDED AND EXECUTED FOR COMPLETION OF THE WORK SPECIFIED IN THE CONTRACT DOCUMENTS FOR THE BID PRICES TABULATED BELOW AS PROPOSED BY THE CONTRACTOR IN ITS PROPOSAL SUBMITTED IN ACCORDANCE WITH NOTICE TO BIDDERS. ALL QUANTITIES ARE SUBJECT TO REVISION BY THE JURISDICTION. QUANTITY CHANGES WHICH AMOUNT TO TWENTY (20) PERCENT OR LESS OF THE AMOUNT BID SHALL NOT AFFECT THE UNIT BID PRICE.

<i>Item</i>	<i>Description</i>	<i>Unit</i>	<i>Quantity</i>	<i>Unit Price</i>	<i>Total Price</i>
1	VALVE BOX EXTENSION	EA	1.0		\$ -
2	MANHOLE ADJUSTMENT, MINOR	EA	3.0		\$ -
3	CURB AND GUTTER	LF	330.0		\$ -
4	REMOVAL OF SIDEWALK	SY	405.3		\$ -
5	SIDEWALK , PCC, 4"	SY	236.8		\$ -
6	SIDEWALK , PCC, 6"	SY	168.8		\$ -
7	DETECTABLE WARNINGS	SF	280.0		\$ -
8	FULL- DEPTH PATCH, PCC, 8"	SY	83.7		\$ -
9	TEMPORARY TRAFFIC CONTROL	LS	1.0		\$ -
Total Project Cost					\$ -

PERFORMANCE, PAYMENT AND MAINTENANCE BOND

KNOW ALL BY THESE PRESENTS:

That we, _____, as Principal
(hereinafter the "Contractor" or "Principal") and

_____, as Surety are held and firmly bound unto
The City of Urbandale, as Obligee (hereinafter referred to as "the Jurisdiction"), and to all persons
who may be injured by any breach of any of the conditions of this Bond in the penal sum of ___ (\$
), lawful money of the United States, for the payment of which sum, well and truly to be made, we
bind ourselves, our heirs, legal representatives and assigns, jointly or severally, firmly by these
presents.

The conditions of the above obligations are such that whereas said Contractor entered into a
contract with the Jurisdiction, bearing date the ___ day of ___, ___, hereinafter the "Contract")
wherein said Contractor undertakes and agrees to construct the following described
improvements:

The 2026 ADA IMPROVEMENTS PROGRAM shall include:

- Approximately 250 SY of 4" PCC Sidewalk
- Approximately 150 SY of 6" PCC Ramps/Landing Spaces
- Approximately 300 LF of Curb and Gutter
- Approximately 100 SY of PCC Patching
- Related items including removals, restoration, traffic control, erosion control, and survey.

and to faithfully perform all the terms and requirements of said Contract within the time therein
specified, in a good and workmanlike manner, and in accordance with the Contract Documents.
Provided, however, that one year after the date of acceptance as complete of the work under the
above referenced Contract, the maintenance portion of this Bond shall continue in force but the
penal sum for maintenance shall be reduced to the sum of ___ (\$___) which is the cost associated
with those items shown on the proposal and in the Contract which require a maintenance bond
period in excess of one year.

Continued – Performance, Payment & Maintenance Bond

It is expressly understood and agreed by the Contractor and Surety in this bond that the following provisions are a part of this Bond and are binding upon said Contractor and Surety, to-wit:

1. **PERFORMANCE:** The Contractor shall well and faithfully observe, perform, fulfill and abide by each and every covenant, condition and part of said Contract and Contract Documents, by reference made a part hereof, for the above referenced improvements, and shall indemnify and save harmless the Jurisdiction from all outlay and expense incurred by the Jurisdiction by reason of the Contractor's default of failure to perform as required. The Contractor shall also be responsible for the default or failure to perform as required under the Contract and Contract Documents by all its subcontractors, suppliers, agents, or employees furnishing materials or providing labor in the performance of the Contract.
2. **PAYMENT:** The Contractor and the Surety on this Bond are hereby agreed to pay all just claims submitted by persons, firms, subcontractors, and corporations furnishing materials for or performing labor in the performance of the Contract on account of which this Bond is given, including but not limited to claims for all amounts due for labor, materials, lubricants, oil, gasoline, repairs on machinery, equipment and tools, consumed or used by the Contractor or any subcontractor, wherein the same are not satisfied out of the portion of the contract price which the Jurisdiction is required to retain until completion of the improvement, but the Contractor and Surety shall not be liable to said persons, firms, or corporations unless the claims of said claimants against said portion of the contract price shall have been established as provided by law. The Contractor and Surety hereby bind themselves to the obligations and conditions set forth in Chapter 573, Code of Iowa, which by this reference is made a part hereof as though fully set out herein.
3. **MAINTENANCE:** The Contractor and the Surety on this Bond hereby agree, at their own expense:
 - A. To remedy any and all defects that may develop in or result from work to be performed under the Contract within the period of Four (4) year(s) from the date of acceptance of the work under the Contract, by reason of defects in workmanship or materials used in construction of said work;
 - B. To keep all work in continuous good repair; and
 - C. To pay the Jurisdiction's reasonable costs of monitoring and inspection to assure that any defects are remedied, and to repay the Jurisdiction all outlay and expense incurred as a result of Contractor's and Surety's failure to remedy any defect as required by this section.

Contractor's and Surety's agreement herein made extends to defects in workmanship or materials not discovered or known to the Jurisdiction at the time such work was accepted.

Continued – Performance, Payment & Maintenance Bond

4. GENERAL: Every Surety on this Bond shall be deemed and held bound, any contract to the contrary notwithstanding, to the following provisions:
- A. To consent without notice to any extension of time to the Contractor in which to perform the Contract;
 - B. To consent without notice to any change in the Contract or Contract Documents, which thereby increases the total contract price and the penal sum of this bond, provided that all such changes do not, in the aggregate, involve an increase of more than twenty percent of the total contract price, and that this bond shall then be released as to such excess increase; and
 - C. To consent without notice that this Bond shall remain in full force and effect until the Contract is completed, whether completed within the specified contract period, within an extension thereof, or within a period of time after the contract period has elapsed and the liquidated damage penalty is being charged against the Contractor.
 - D. That no provision of this Bond or of any other contract shall be valid which limits to less than five years after the acceptance of the work under the Contract the right to sue on this Bond.
 - E. That as used herein, the phrase “all outlay and expense” is not to be limited in any way, but shall include the actual and reasonable costs and expenses incurred by the Jurisdiction including interest, benefits and overhead where applicable. Accordingly, “all outlay and expense” would include but not be limited to all contract or employee expense, all equipment usage or rental, materials, testing, outside experts, attorneys fees (including overhead expenses of the Jurisdiction’s staff attorneys), and all costs and expenses of litigation as they are incurred by the Jurisdiction. It is intended the Contractor and Surety will defend and indemnify the Jurisdiction on all claims made against the Jurisdiction on account of Contractor’s failure to perform as required in the Contract and Contract Documents, that all agreements and promises set forth in the Contract and Contract Documents, in approved change orders, and in this Bond will be fulfilled, and that the Jurisdiction will be fully indemnified so that it will be put into the position it would have been in had the Contract been performed in the first instance as required.

In the event the Jurisdiction incurs any “outlay and expense” in defending itself with respect to any claim as to which the Contractor or Surety should have provided the defense, or in the enforcement of the promises given by the Contractor in the Contract, Contract Documents, or approved change orders, or in the enforcement of the promises given by the Contractor and Surety in this Bond, the Contractor and Surety agree that they will make the Jurisdiction whole for all such outlay and expense, provided that the Surety’s obligation under this bond shall not exceed 125% of the penal sum of this bond.

Continued – Performance, Payment & Maintenance Bond

In the event that any actions or proceedings are initiated with respect to this Bond, the parties agree that the venue thereof shall be Polk and Dallas County, State of Iowa. If legal action is required by the Jurisdiction to enforce the provisions of this Bond or to collect the monetary obligation incurring to the benefit of the Jurisdiction, the Contractor and the Surety agree, jointly and severally, to pay the Jurisdiction all outlay and expense incurred therefore by the Jurisdiction. All rights, powers, and remedies of the Jurisdiction hereunder shall be cumulative and not alternative and shall be in addition to all rights, powers, and remedies given to the Owner, by law. The Jurisdiction may proceed against Surety for any amount guaranteed hereunder whether action is brought against the Contractor or whether Contractor is joined in any such action or actions or not.

NOW THEREFORE, the condition of this obligation is such that if said Principal shall faithfully perform all the promises of the Principal, as set forth and provided in the Contract, in the Contract Documents, and in this Bond, then this obligation shall be null and void, otherwise it shall remain in full force and effect.

When a work, term, or phrase is used in this Bond, it shall be interpreted or construed first as defined in this Bond, the Contract, or the Contract Documents; second, if not defined in the Bond, Contract, or Contract Documents, it shall be interpreted or construed as defined in applicable provisions of the Iowa Code; third, if not defined in the Iowa Code, it shall be interpreted or construed according to its generally accepted meaning in the construction industry; and fourth, if it has no generally accepted meaning in the construction industry, it shall be interpreted or construed according to its common or customary usage.

Failure to specify or particularize shall not exclude terms or provisions not mentioned and shall not limit liability hereunder. The Contract and Contract Documents are hereby made a part of this Bond.

Continued – Performance, Payment & Maintenance Bond

Witness our hands, in triplicate, this _____ day of _____, _____.

Surety Countersigned By:

PRINCIPAL:

Signature of Agent

Contractor

By: _____
Signature

Printed Name of Agent

Title

Company Name

SURETY:

Company Address

Surety Company

City, State, Zip Code

By: _____
Signature Attorney-in-Fact Officer

Company Telephone Number

Name of Attorney-in-Fact Officer

Company Name

Company Address

City, State, Zip Code

Company Telephone Number

NOTE: All signatures on this performance, maintenance & payment bond must be original signatures in ink; copies or facsimile of any signature will not be accepted. This bond must be sealed with the Surety's raised, embossing seal. The Certificate or Power of Attorney accompanying this bond must be valid on its face and sealed with the Surety's raised, embossing seal.

TITLE VI ASSURANCES: APPENDIX A

During the performance of this contract, the contractor, for itself, its assignees and successors in interest (hereinafter referred to as the "contractor") agrees as follows:

1. Compliance with Regulations: The contractor shall comply with the Regulations relative to nondiscrimination in Federally-assisted programs of the Department of Transportation (hereinafter, "DOT") Title 49, Code of Federal Regulations, Part 21, as they may be amended from time to time, (hereinafter referred to as the Regulations), which are herein incorporated by reference and made a part of this contract.
2. Non-Discrimination: The contractor, with regard to the work performed by it during the contract, shall not discriminate on the grounds of race, color, national origin, sex, age, or disability in the selection and retention of subcontractors, including procurement of materials and leases of equipment. The contractor shall not participate either directly or indirectly in the discrimination prohibited by section 21.5 of the Regulations, including employment practices when the contract covers a program set forth in Appendix B of the Regulations.
3. Solicitations for Subcontracts, Including Procurement of Materials and Equipment: In all solicitations either by competitive bidding or negotiation made by the contractor for work to be performed under a subcontract, including procurement of materials or leases of equipment, each potential subcontractor or supplier shall be notified by the contractor of the contractor's obligations under this contract and the Regulations relative to non-discrimination on the grounds of race, color, national origin, sex, age, or disability.
4. Information and Reports: The contractor shall provide all information and reports required by the Regulations or directives issued pursuant thereto, and shall permit access to its books, records, accounts, other sources of information, and its facilities as may be determined by the City of Urbandale, the Iowa Department of Transportation or Federal Highway Administration to be pertinent to ascertain compliance with such Regulations, orders and instructions. Where any information required of a contractor is in the exclusive possession of another who fails or refuses to furnish this information the contractor shall so certify to the City of Urbandale, the Iowa Department of Transportation or the Federal Highway Administration as appropriate, and shall set forth what efforts it has made to obtain the information.
5. Sanctions for Non-Compliance: In the event of the contractor's noncompliance with the non-discrimination provisions of this contract, the City of Urbandale shall impose such contract sanctions as it, the Iowa Department of Transportation or the Federal Highway Administration may determine to be appropriate, including, but not limited to:
 - a. withholding of payments to the contractor under the contract until the contractor complies, and/or
 - b. cancellation, termination, or suspension of the contract, in whole or in part.
6. Incorporation of Provisions: The contractor shall include the provisions of paragraphs (1) through (6) in every subcontract, including procurement of materials and leases of equipment, unless exempt by the Regulations, or directives issued pursuant thereto. The contractor shall take such action with respect to any subcontract or procurement as the City of Urbandale, the Iowa Department of Transportation or the Federal Highway Administration may direct as a means of enforcing such provisions including sanctions for non-compliance: Provided, however, that, in the event a contractor becomes involved in, or is threatened with, litigation with a subcontractor or supplier as a result of such direction, the contractor may request the City of Urbandale or the Iowa Department of Transportation to enter into such litigation to protect the interests of the City of Urbandale or the Iowa Department of Transportation; and, in addition, the contractor may request the United States to enter into such litigation to protect the interests of the United States.

Bidder Status Form

To be completed by all bidders

Part A

Please answer "Yes" or "No" for each of the following:

- Yes No My company is authorized to transact business in Iowa.
(To help you determine if your company is authorized, please review the worksheet on the next page).
- Yes No My company has an office to transact business in Iowa.
- Yes No My company's office in Iowa is suitable for more than receiving mail, telephone calls, and e-mail.
- Yes No My company has been conducting business in Iowa for at least 3 years prior to the first request for bids on this project.
- Yes No My company is not a subsidiary of another business entity or my company is a subsidiary of another business entity that would qualify as a resident bidder in Iowa.
If you answered "Yes" for each question above, your company qualifies as a resident bidder.
Please complete Parts B and D of this form.
If you answered "No" to one or more questions above, your company is a non-resident bidder.
Please complete Parts C and D of this form.

To be completed by resident bidders

Part B

My company has maintained offices in Iowa during the past 3 years at the following addresses:

Dates: _____ to _____ Address: _____
(mm/dd/yyyy) City, State, Zip: _____

Dates: _____ to _____ Address: _____
 City, State, Zip: _____

Dates: _____ to _____ Address: _____
You may attach additional sheet(s) if needed. City, State, Zip: _____

To be completed by non-resident bidders

Part C

1. Name of home state or foreign country reported to the Iowa Secretary of State: _____
2. Does your company's home state or foreign country offer preferences to resident bidders, resident labor force, or any other type of preference to bidders or laborers? Yes No
3. If you answered "Yes" to question 2, identify each preference offered by your company's home state or foreign country and the appropriate legal citation.

You may attach additional sheet(s) if needed.

To be completed by all bidders

Part D

I certify that the statements made on this document are true and complete to the best of my knowledge and I know that my failure to provide accurate and truthful information may be a reason to reject my bid.

Firm Name: _____

Signature: _____ Date: _____

Worksheet: Authorization to Transact Business

This worksheet may be used to help complete Part A of the Resident Bidder Status form. If at least one of the following describes your business, you are authorized to transact business in Iowa.

- Yes No My business is currently registered as a contractor with the Iowa Division of Labor.

- Yes No My business is a sole proprietorship and I am an Iowa resident for Iowa income tax purposes.

- Yes No My business is a general partnership or joint venture. More than 50 percent of the general partners or joint venture parties are residents of Iowa for Iowa income tax purposes.

- Yes No My business is an active corporation with the Iowa Secretary of State and has paid all fees required by the Secretary of State, has filed its most recent biennial report, and has not filed articles of dissolution.

- Yes No My business is a corporation whose articles of incorporation are filed in a state other than Iowa, the corporation has received a certificate of authority from the Iowa Secretary of State, has filed its most recent biennial report with the Secretary of State, and has neither received a certificate of withdrawal from the Secretary of state nor had its authority revoked.

- Yes No My business is a limited liability partnership which has filed a statement of qualification in this state and the statement has not been canceled.

- Yes No My business is a limited liability partnership which has filed a statement of qualification in a state other than Iowa, has filed a statement of foreign qualification in Iowa and a statement of cancellation has not been filed.

- Yes No My business is a limited partnership or limited liability limited partnership which has filed a certificate of limited partnership in this state, and has not filed a statement of termination.

- Yes No My business is a limited partnership or a limited liability limited partnership whose certificate of limited partnership is filed in a state other than Iowa, the limited partnership or limited liability limited partnership has received notification from the Iowa Secretary of state that the application for certificate of authority has been approved and no notice of cancellation has been filed by the limited partnership or the limited liability limited partnership.

- Yes No My business is a limited liability company whose certificate of organization is filed in Iowa and has not filed a statement of termination.

- Yes No My business is a limited liability company whose certificate of organization is filed in a state other than Iowa, has received a certificate of authority to transact business in Iowa and the certificate has not been revoked or canceled.

**City of Urbandale
Supplemental Specifications
To Iowa Statewide Urban Design and Specifications
Standard Specifications for Public Improvements – 2026 Edition
January 2026**

Division	Section	Page/ Figure	Description of Change
1	1040 1.09	4	Delete all of 1.09, A & B
1	1040 1.10	5	1.10,A Add “6. Under no circumstances will payment for down time be made by the City of Urbandale as project field issues are being resolved. The City of Urbandale will take all necessary action to resolve issues in a timely manner.”
1	1040 1.10	5 & 6	<p>Delete all of 1.10, D, E, F, and G</p> <p>Insert 1.10, D “Arbitration Procedures”</p> <ol style="list-style-type: none"> 1. Contractor shall not cause a delay of work during arbitration proceedings except by agreement with Owner. 2. Unless otherwise provided by controlling statutes parties may agree upon one arbitrator; otherwise there shall be three, one named by each party to this contract and a third chosen by two arbitrators so selected. If two arbitrators fail to select a third within fifteen (15) days then a third shall be chosen by any District Judge, to whom application in writing is made, of Judicial District in which work is to be performed. Should party demanding arbitration fail to name an arbitrator within ten (10) days of the demand, the right to arbitration shall lapse. Should other party fail to choose an arbitrator within said ten (10) days the party seeking arbitration shall make application in writing to any District Judge of the Judicial District in which the work is to be performed for appointment of a second arbitrator. If two arbitrators so chosen shall fail to select a third within fifteen (15) days then upon application of either of them to any District Judge of the Judicial District in which work is to be performed said third arbitrator shall be designated by said Judge. 3. Should either party refuse or neglect to supply arbitrators with any papers or information demanded in writing, the arbitrators are empowered by both parties ex parte. 4. Arbitrators shall be authorized to award to party whose contention is sustained such sums as they shall deem property for time, expense and trouble incident to appeal and, if appeal was taken without reasonable cause, damages for delay. Arbitrators shall fix their own compensation, unless otherwise provided by agreement, and shall assess costs and charges of arbitrator upon either or both parties. 5. Award of arbitrators shall be in writing and it shall not be open to objection on account of form of proceeding or award, unless otherwise provided by controlling statutes.

Division	Section	Page/ Figure	Description of Change
1	1040 1.11	6	1.11 Insert "Under no circumstances will payment for down time be made by the City of Urbandale as project field issues are being resolved. The City of Urbandale will take all necessary action to resolve issues in a timely manner."
1	1070 2.02	7	2.02,E,6 Insert "The Jurisdiction's Safety Plan is available upon request from the Engineer. The jurisdiction will make available a copy of the Jurisdiction's Safety Plan to the Contractor when the contract is awarded. Said Safety Plan is for the Contractor's information only and it is the Contractor's sole responsibility to provide, or make available this safety information to all its Subcontractors."
1	1090 1.08	3	1.08,E Insert "Lien Waivers from all subcontractors shall be submitted by the Contractor before final acceptance by the Jurisdiction."
2	2010 2.03	8	2.03,F Insert "F. Manufactured sand shall not be used for embankment."
2	2010 2.04	11	2.04,D,4 Insert "4. Manufactured sand shall not be used for subgrade, neither for new construction nor for patches and repair work."
2	2010 3.06	17	3.06,B,4 Insert "4. Proof rolling shall be considered void if subgrade is disturbed, including but not limited to: loadings on the grade, weather, or extended time delays. Engineer shall have discretion to require a new proof roll as needed to verify current condition of subgrade."
3	3010 2.01	4	2.01,A,2,i Insert "i. Manufactured sand."
4	4010 3.04	11	3.04,F, 1 Insert "Contractor to use a stiff coupling such as a Smith Blair 261, Smith Blair 441, HyMax Coupling, Romac Industries 501, Romac Industries LSS1, LSS2, LSS3 or approved equal. Rubber couplings and rubber couplings with shear bands are prohibited. No other couplings allowed except as permitted by the Engineer."
4	4020 3.06	8	3.06,B Replace first sentence with "Install apron footings on all concrete aprons. Install apron footings on other aprons where specified."
4	4030 3.02	5	3.02,B, Replace first sentence with "Install apron footings on all concrete aprons. Install apron footings on other aprons where specified."
4	4040 2.01	3	2.01 Add "(Non-perforated pipe)"
4	4050 3.07	23	3.07, D Insert "Contractor to use a stiff coupling such as a Smith Blair 261, Smith Blair 441, HyMax Coupling, or approved equal. Rubber couplings and rubber couplings with shear bands are prohibited. No other couplings allowed except as permitted by the Engineer."
4	4060 3.02	3	3.02,A,5 Insert "Video inspection to be performed after backfill over sanitary sewer has been in place a minimum of 30 days and prior to paving operations unless approved earlier by Engineer. Pavement placement prior to 30 days after backfill at contractor's risk."

Division	Section	Page/ Figure	Description of Change
5	5010 5111 5020 5030 All	All	Delete entire Division and insert "Water main standards in the City of Urbandale shall meet the requirements of the current edition of Urbandale Water Utility Standard Specifications for Water Mains and Appurtenances."
6	6010 2.02	5	2.02,A Insert "A. Precast Requirements: the City of Urbandale will allow precast intakes and rectangular storm sewer manholes when all of the following conditions are met: 1. Construction is new and not a replacement of an existing structure. 2. Pipe diameter is 24" or less. 3. Minimum 75° separation is provided between pipes, and between pipe and face of structure. 4. Precast portion is a dead end structure, cross-run structure or directional change structure. 5. Pipe opening does not encroach within 2 inches of corner post."
6	6010 2.09	7	Delete 2.09,A,1. Only High Density Polyethylene Adjustment Rings or Expanded Polypropylene Adjustment Rings are allowed.
6	6010 2.10	8	2.10,E,2,b replace with "Casting shall include stamped message 'DUMP NO WASTE, DRAINS TO STREAM' or Engineer approved equivalent."
6	6010 2.12	10	2.12,C Insert "C. Provide invert and 2' stub for future sewer extension."
6	6010 2.16	11	2.16,A Insert "Internal drop connection not allowed except with prior approval of Engineer."
6	6010 3.01	13	3.01,H Replace with "Install manhole eccentric cone or flat top section or install intake top, embedded in grout."
6	6010 3.05	18	3.05,D,1 Insert "Use only when specified." 3.05,D,2a Replace with "a. Core drill new openings in existing manholes or intakes for all pipes unless otherwise specified in the contract documents. Notify the Jurisdiction for inspection prior to placing backfill material."
6	6010 3.06	18	3.06,A, Insert "Internal drop connection not allowed except with prior approval of Engineer."
6	6010	6010.304	Insert "Structure shall only be used in extenuating circumstances and with prior approval of Jurisdiction."
6	6010	6010.308	Insert "Internal drop connection requires prior approval of Engineer."
6	6010	6010.514	Replace 'ED' Joint with a 'RD' Joint.
7	7010 1.08	4	Delete Section N in its entirety.
7	7010 2.01	5	2.01,H Insert "Glass fiber reinforced polymer dowel bars require prior approval by Engineer, and shall not be allowed on arterials or streets with more than two lanes."

Division	Section	Page/ Figure	Description of Change
7	7010 2.02	8	2.02,D Insert "D. All paving to be C4 mix."
7	7010 3.07	25 & 26	3.07,C.1 Replace first sentence with "The Contractor will check PCC pavement surfaces with a 10 foot straightedge placed parallel to the centerline in the presence of City Staff." 3.07,C.2.d Insert "d. Pavements 8" and greater in thickness will be evaluated for smoothness." 3.07,D,1. Insert new sentence "Jurisdiction reserves the right to waive cores."
7	7010	7010.901	Detail 7010.901 Gutter line jointing is the City of Urbandale's preferred jointing. Insert General Note #6 – "No dowels or joints in the curb and gutter section of pavement for 26' B/B."
7	7020 1.02	1	1.02,C Insert "C. City of Urbandale shall comply with section 7020, 3.06 for HMA Quality Control. QMA shall be waived." 1.02,D Insert "D. Use of Hot Mix Asphalt Pavement for streets and related work will only be permitted with prior Jurisdictional Engineer approval."
7	7020 1.08	5	Delete Section M in its entirety.
7	7020 3.01	7	Delete Section H in its entirety.
7	7020 3.05	12	3.05,A Replace first sentence with "The Contractor will check asphalt pavement surfaces with a 10 foot straightedge placed parallel to the centerline in the presence of City Staff."
7	7030 2.07	6	2.07 Insert "Detectable warning panels to be Armor Tile, ADA Solutions or approved equal, Federal Color No. 20109 (typically brick red) in color, cast-in-place. Submit proposed panel with material submittals for review."
7	7030 3.02	7	Delete 3.02,A,1 and insert 3.02,A,1 "Subgrade Preparation: Subgrade to meet requirements of 3.02,B, Sidewalk and Driveways."
7	7030	7030.101	Replace with Urbandale Figure 7030.101
7	7030	7030.102	Replace with Urbandale Figure 7030.102
7	7030	7030.204	Replace with Urbandale Figure 7030.204
9	9070 1.03	1	1.03,D Insert "D. Submit a minimum of three color choices, not to include gray, from the Manufacturer's standard colors for approval."
9	9070 2.01	3	2.01,A,1,e Insert "e. block weight to be minimum 75 pounds per block."
9	9071 1.03	1	1.03,F Insert "F. Submit a minimum of three color choices, not to include gray, from the Manufacturer's standard colors for approval."

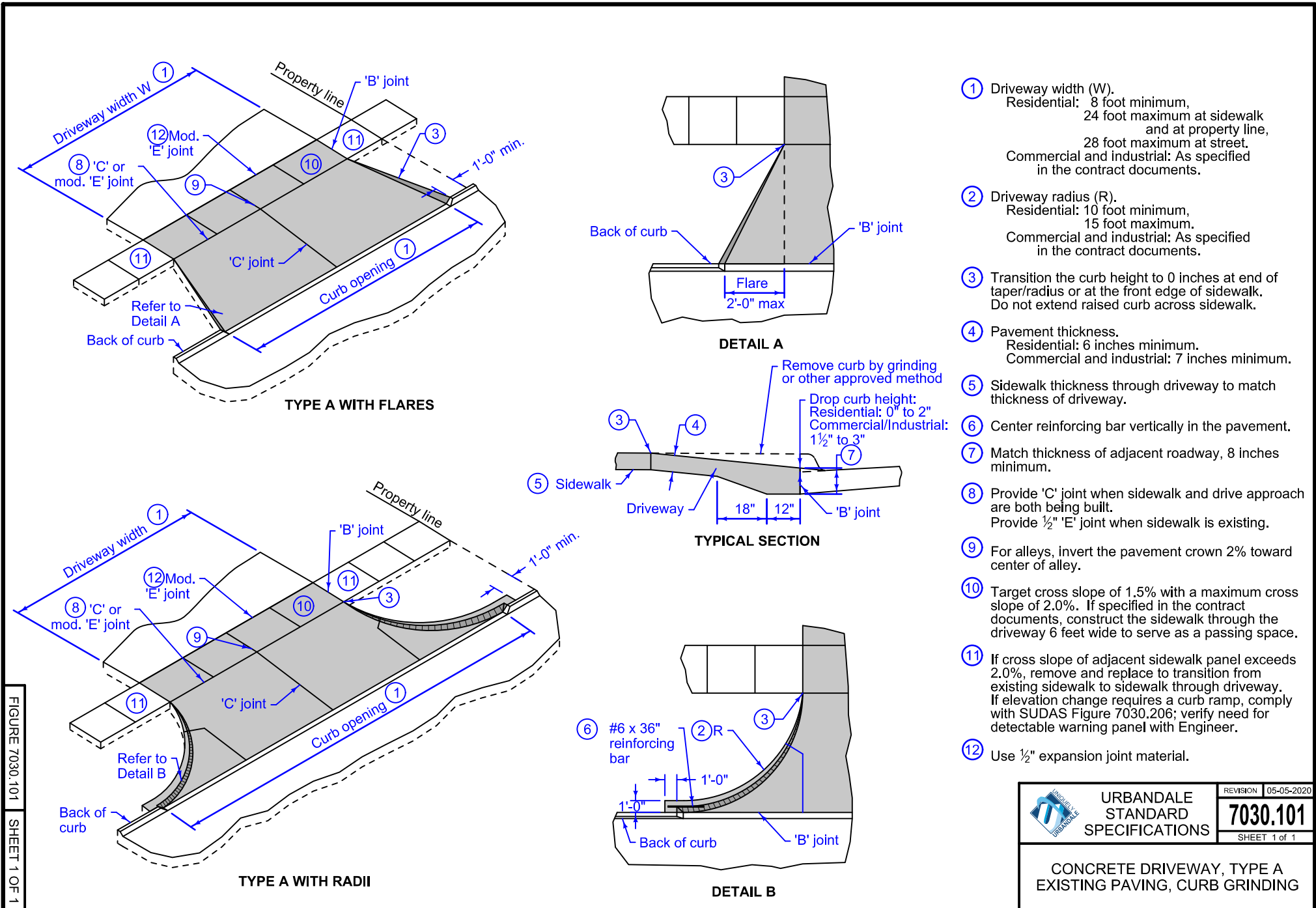

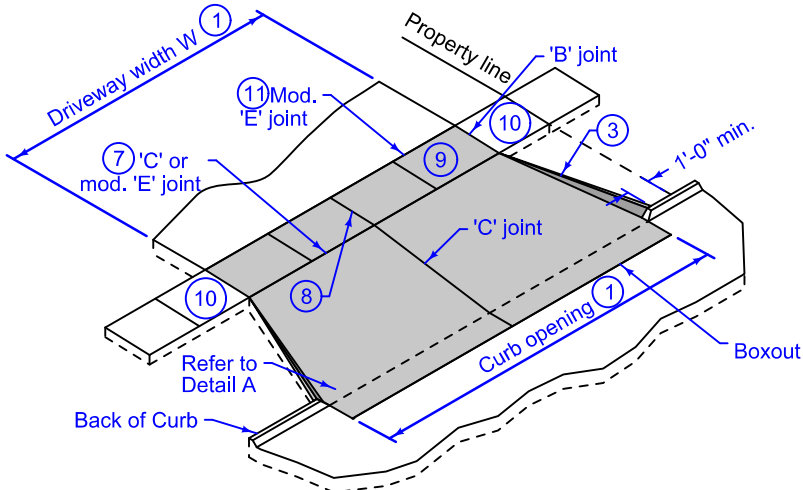

FIGURE 7030.101 SHEET 1 OF 1

 URBAN DALE STANDARD SPECIFICATIONS	REVISION 05-05-2020
	7030.101 SHEET 1 of 1
CONCRETE DRIVEWAY, TYPE A EXISTING PAVING, CURB GRINDING	

THIS DETAIL ONLY TO BE USED WITH PRIOR APPROVAL FROM CITY OF URBANDALE ENGINEERING DEPARTMENT.



TYPE B WITH FLARES

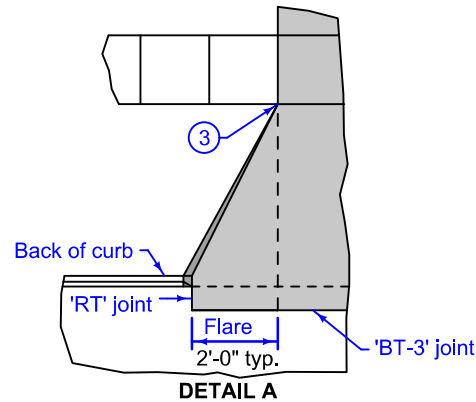

DETAIL A

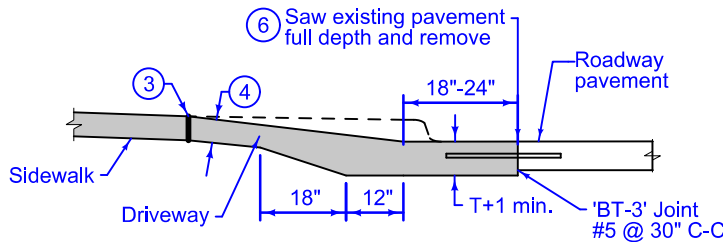

SECTION A-A

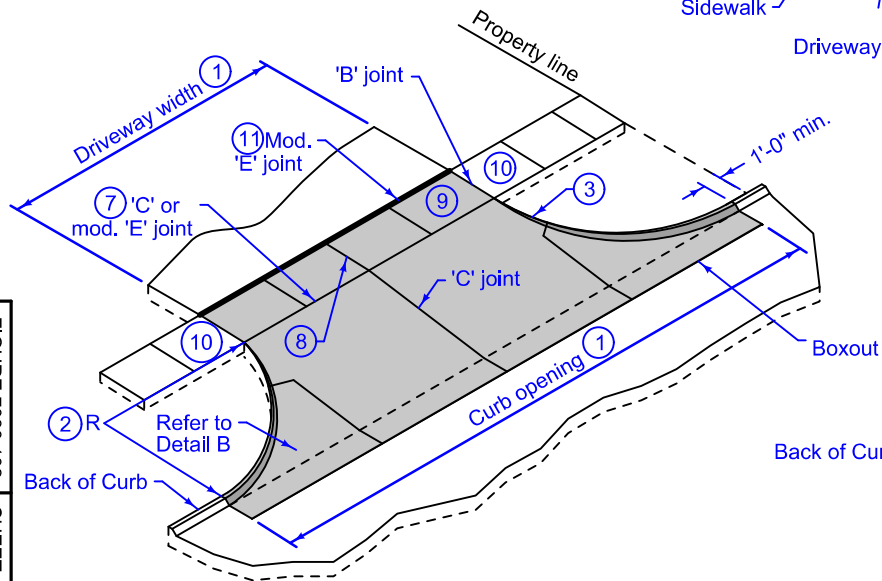

TYPE B WITH RADII

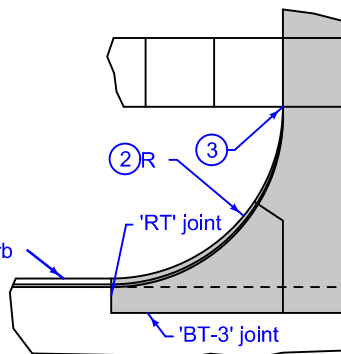

DETAIL B

- ① Driveway width (W).
Residential: 8 foot minimum, 24 foot maximum at sidewalk and at property line, 28 foot maximum at street.
Commercial and industrial: As specified in the contract documents.
- ② Driveway radius (R).
Residential: 10 foot minimum, 15 foot maximum.
Commercial and industrial: As specified in the contract documents.
- ③ Transition the curb height to 0 inches at end of taper/radius or at the front edge of sidewalk. Do not extend raised curb cross sidewalk.
- ④ Pavement thickness.
Residential: 6 inches minimum.
Commercial and industrial: 7 inches minimum.
- ⑤ Sidewalk thickness through driveway to match thickness of driveway.
- ⑥ If longitudinal joint is located 48 inches or less from the back of curb, extend boxout to joint line. Full depth saw cut is still required.
- ⑦ Provide 'C' joint when sidewalk and drive approach are both being built. Provide 1/2" 'E' joint when sidewalk is existing.
- ⑧ For alleys, invert the pavement crown 2% toward the center of the alley.
- ⑨ Target cross slope of 1.5% with a maximum cross slope of 2.0%. If specified in the contract documents, construct the sidewalk through the driveway 5 feet wide to serve as a passing space.
- ⑩ If cross slope of adjacent sidewalk panel exceeds 2.0%, remove and replace to transition from existing sidewalk to sidewalk through driveway. If elevation change requires a curb ramp, comply with SUDAS Figure 7030.205; verify need for detectable warning panel with Engineer.
- ⑪ Use 1/2" expansion joint material.

FIGURE 7030.102 SHEET 1 OF 1



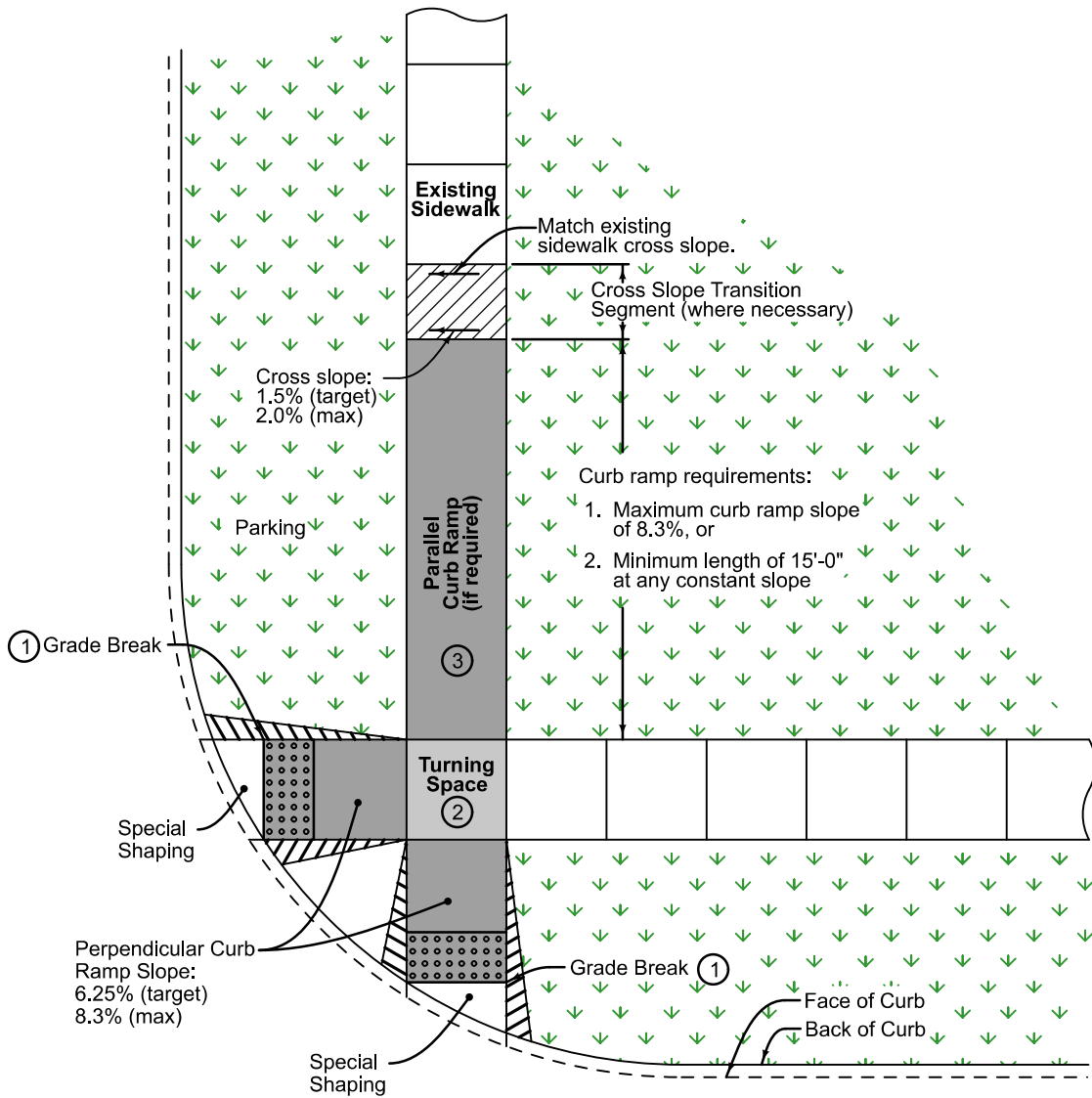

	URBANDALE STANDARD SPECIFICATIONS	REVISION 04-29-16
	7030.102	SHEET 1 of 1

CONCRETE DRIVEWAY, TYPE B
EXISTING PAVING WITH CURB CUT



- ① Match pedestrian street crossing slope, or flatter.
- ② Minimum 5 feet by 5 feet, unless approved by Engineer. Target slope = 1.5%; maximum slope = 2.0% perpendicular to adjoining sidewalks and curb ramps.
- ③ All Urbandale Sidewalks to be 5 feet wide, unless approved by Engineer.
- ④ Detectable warning panels to be Armor Tile, ADA Solutions, or approved equal, Federal Color No.20109 (typically brick red) in color, cast-in-place. Brick pavers will not be allowed.

Key

-  Curb Ramp
-  Turning Space
-  Detectable Warning ④
-  Grass

	URBANDALE STANDARD SPECIFICATIONS	REVISION 01/14/2026
		7030.204 SHEET 1 of 1
GENERAL FEATURES OF AN ACCESSIBLE SIDEWALK		

PLANS LIST

2026 ADA IMPROVEMENTS PROGRAM
URBANDALE, IOWA

1. PLANS

1.1 The work shall conform with the following Drawings (bound separately) and Detail and Standard Drawings, all of which constitute the "Plans" and are an integral part of the Contract Documents.

	TITLE	DRAWING NUMBER
	Title Sheet	A.01
	Quantities and General Information	C.01-C.02
	Sidewalk Sheets	D.01-D.07